

90 X 80 X 40 CM

35.4" X 31.4" X 15.7"

MADERCLICK MINI 3/400

5 Años Garantía
Years Guarantee
Jahre Garantie
Ans Garantie
Anos de Garantia
SIMONRACK

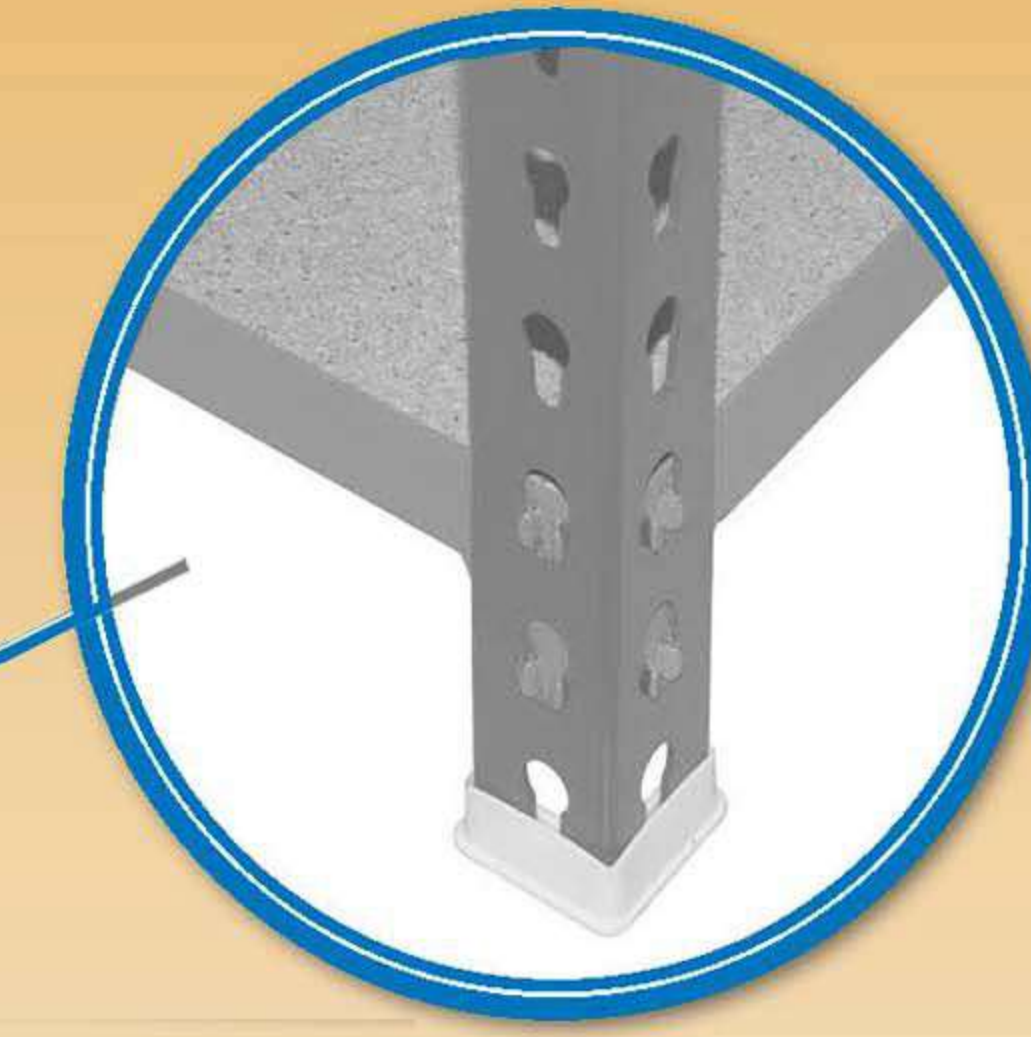
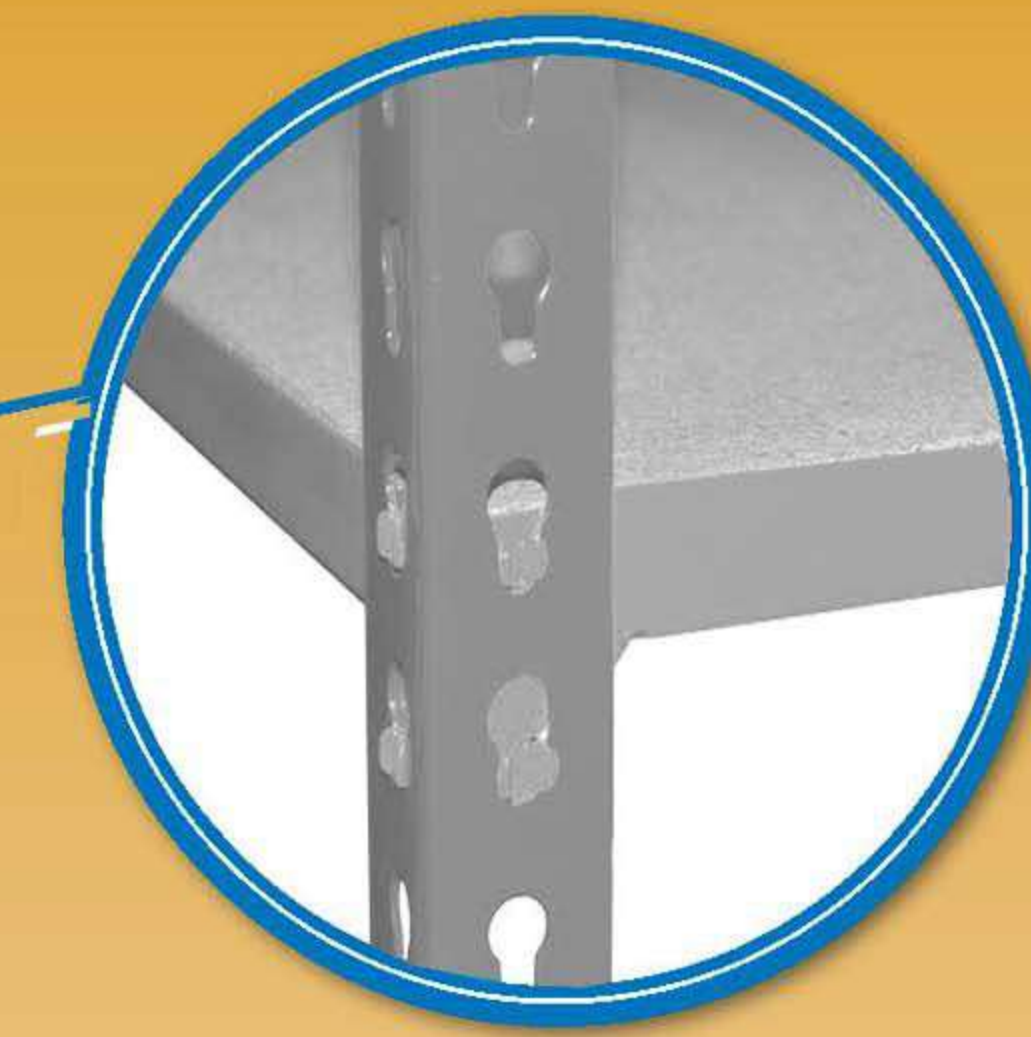
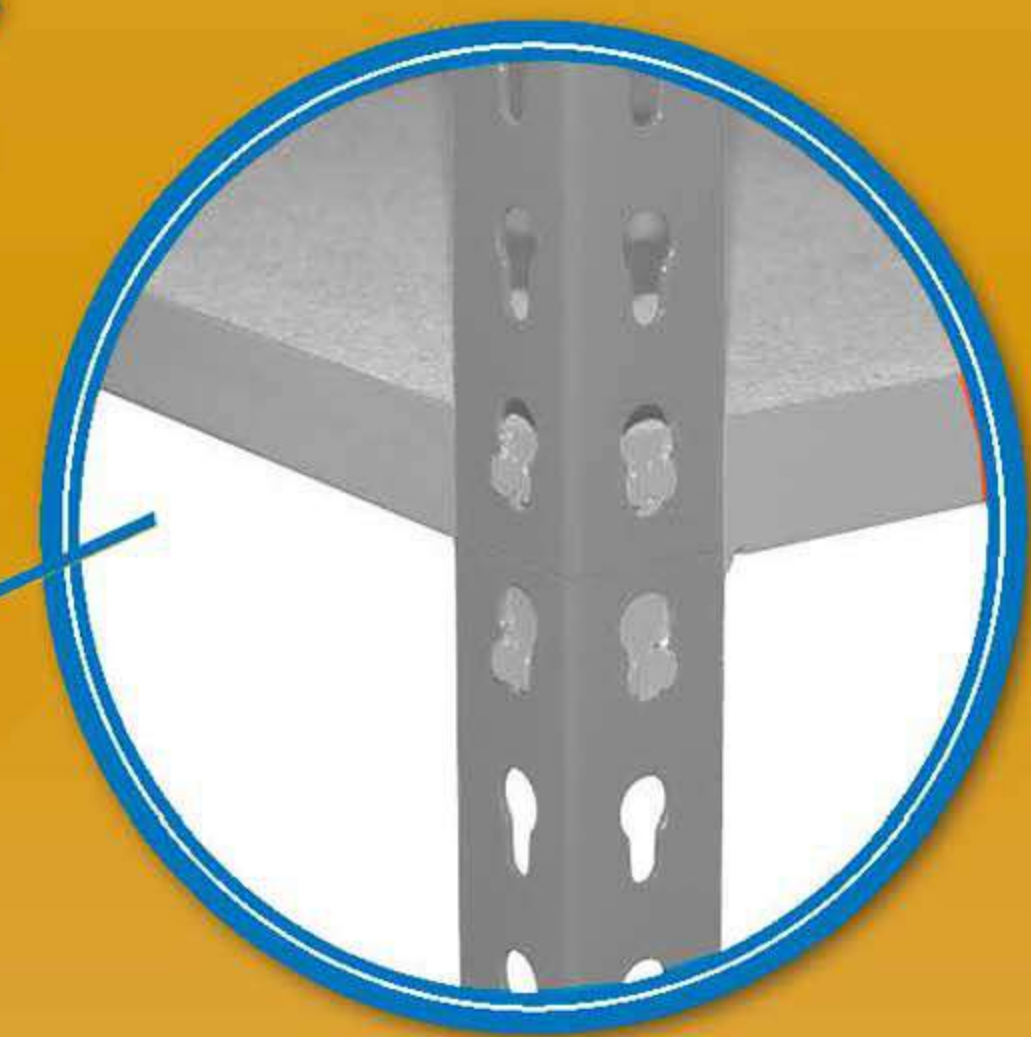

*MEDIDAS EN USO USED MEASUREMENTS
MASSNAHMEN IM EINSATZ MESURES EN EMPLOI MEDIDAS EM USO:
877 x 910 x 410 mm (34.5" x 35.8" x 16.1")



ESTANTERIAS SIMON S.L. B.50.556.463
PG. ALFAMEN C/ POLIGONO C, N°3
ALFAMEN (ZARAGOZA)

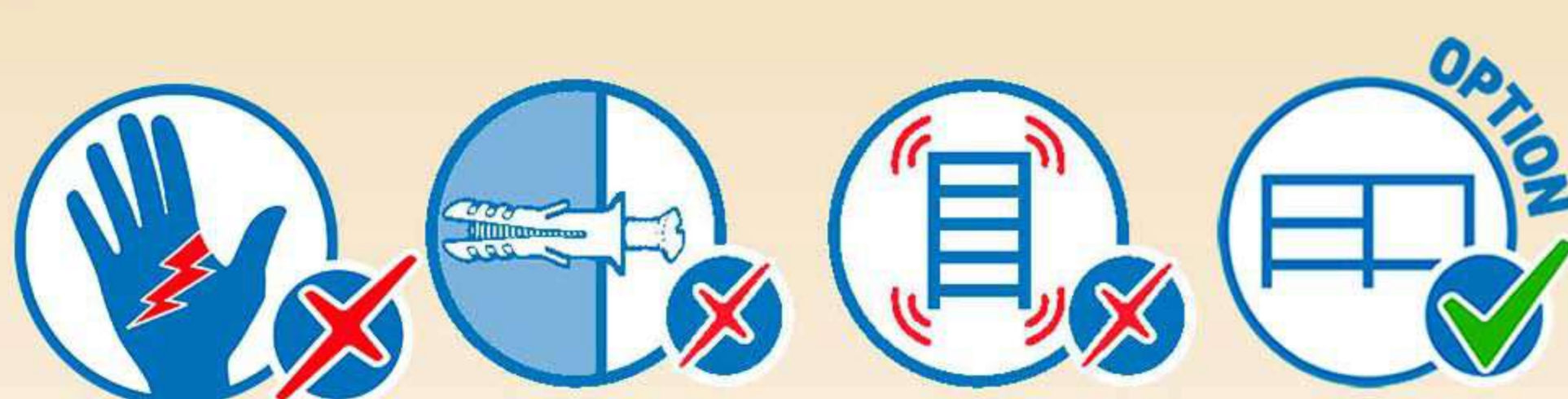

**Simon
Rack**
SINCE 1964 - MANUFACTURER



www.simonrack.com



INSTRUCTIONS

