

90 X 100 X 50 CM

35.4" X 39.3" X 19.7"

MADERCLICK PLUS 3/500

5 Años Garantía
Years Guarantee
Jahre Garantie
Ans Garantie
Anos de Garantia
SIMONRACK

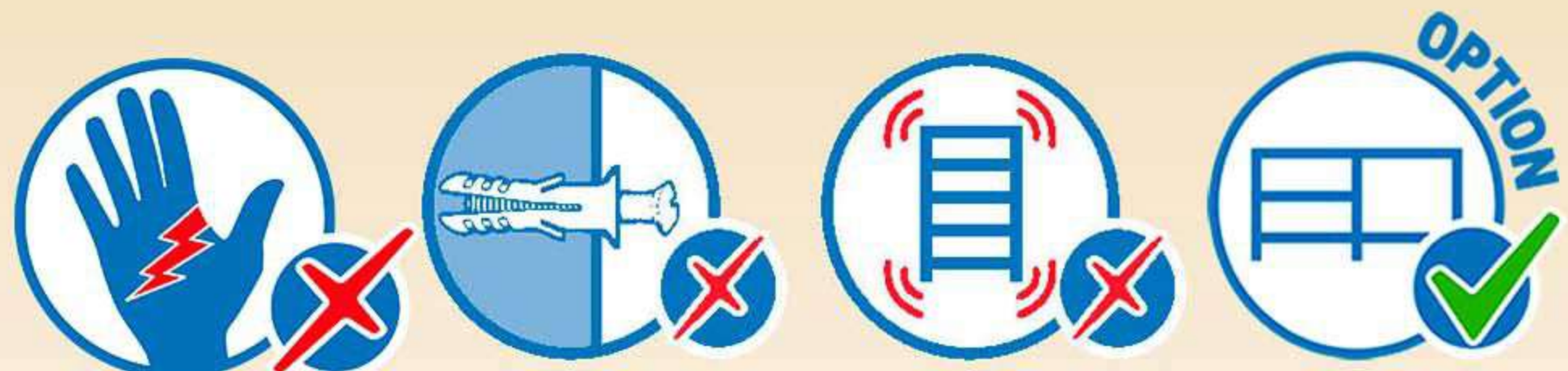
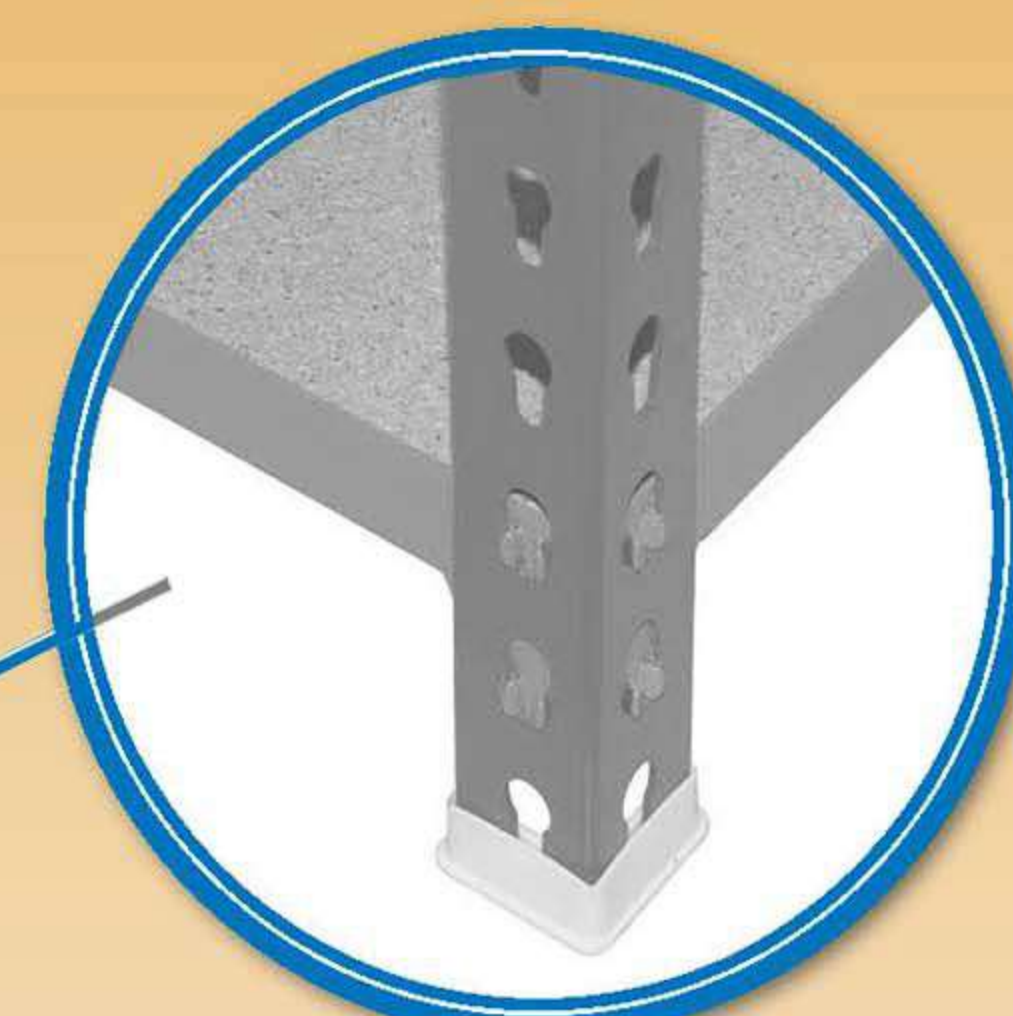
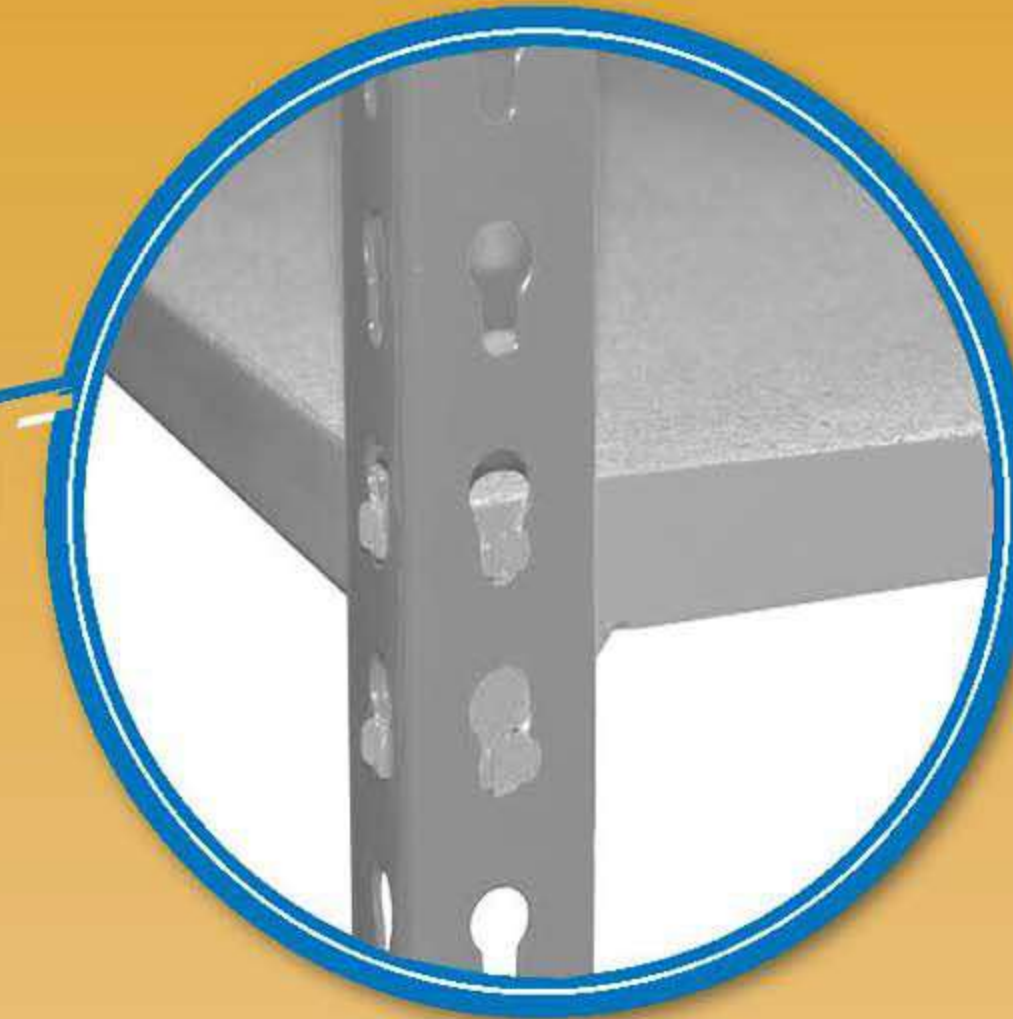
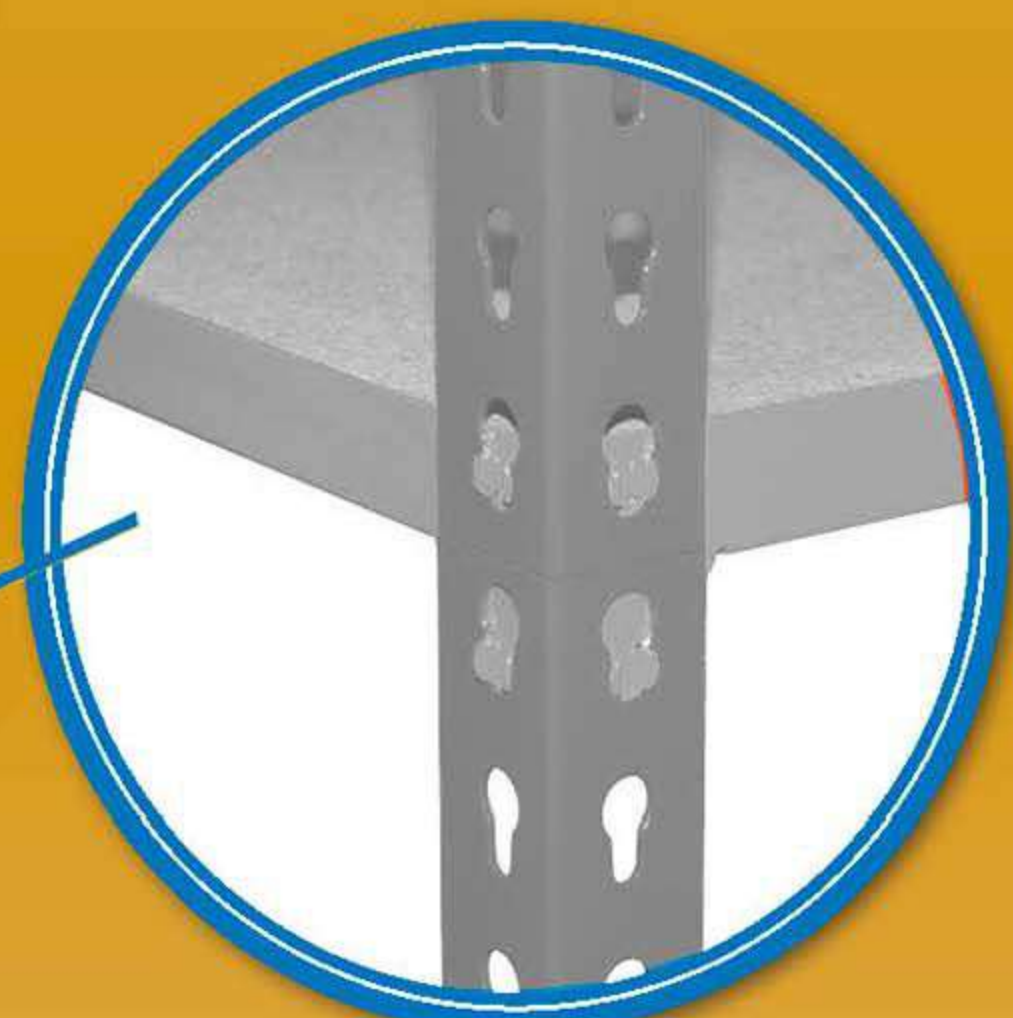

*MEDIDAS EN USO USED MEASUREMENTS
MASSNAHMEN IM EINSATZ MESURES EN EMPLOI MEDIDAS EM USO:
877 x 1010 x 510 mm (34.5" x 39.7" x 20.1")



ESTANTERIAS SIMON S.L. B.50.556.463
PG. ALFAMEN C/ POLIGONO C, N°3
ALFAMEN (ZARAGOZA)



Simon Rack
SINCE 1964 - MANUFACTURER



www.simonrack.com



INSTRUCTIONS

